

# Shuttle – Preventive Maintenance

## ⚡ ⚠ WARNING ⚠ ⚡

- Before attempting any maintenance on this equipment all involved personnel should follow plant internal regulations along with any state, federal, or province regulations.
- The maintenance inspection, checks, and procedures listed in the preventive maintenance tables are assumed with the gated area electrically locked out.
- Before attempting any maintenance or service operation, make sure that:
  - You do not begin any repair procedure until the proper shutdown procedures and the appropriate power lockout procedures have been applied.
  - The system is de-energized; main electrical switches are open.

## ⓘ NOTICE ⓘ

The maintenance inspection, checks, and procedures listed in the preventive maintenance tables and corrective procedures should be performed when the equipment is immobilized and locked out.

This section contains preventive maintenance schedules with recommended lubrication intervals. Assemblies in this section include:

- **Shuttle**
- **Skillet Power Roll Bed**

## Daily Checks

### Observe

- Obvious signs of damage to the equipment. Listen to the conveyors - an unusual sound like screeching, grinding, or whining, are indicators of a problem.
- Damage or noticeable wear on the carrying and guide rollers.
- Signs of oil leaks on the equipment or on the floor below any gearbox.

### Evaluate

- If you notice any of the above issues, evaluate the cause and the risk involved.

### Act

- Schedule or perform necessary maintenance repairs as appropriate.

## Mechanical Preventive Maintenance - key

Preventive Maintenance tables consists of:



Item No.	Item Name	Required Operation	Description	Interval
1	Gearmotor	Inspection	<ul style="list-style-type: none"> <li>Visually inspect gear unit for oil leakage. Check for oil film or grease deposits – clean if necessary.</li> <li>Check mounting hardware, check paint marks...</li> </ul>	6 Months

- A. Indicates the callout number associated on the schematic drawing, image or figure.
- B. Component name within the assembly.
- C. Required preventive maintenance operation - i.e., inspection or lubrication.
- D. Detailed description of the operation(s) to be performed.
- E. Recommended frequency of PM task.

## Shuttle – Preventive Maintenance Items

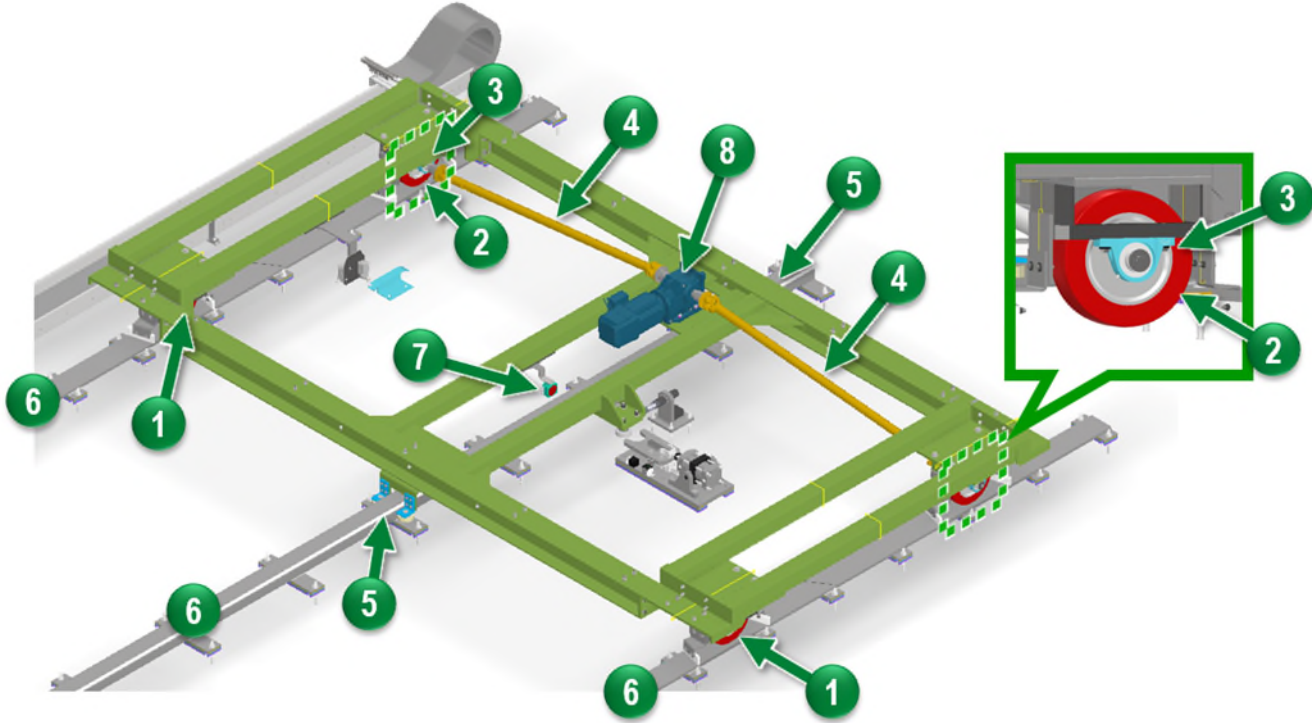

Item No.	Item Name	Required Operation	Description	Interval
1	Idle Wheel	Inspection	<ul style="list-style-type: none"> <li>Observing how the wheel sits in the frame and how it follows the turntable track.</li> <li>Check mounting hardware for proper tightness. Look for paint mark alignment on hardware-retighten if necessary.</li> <li>Check the condition of the wheel surface. It should not have any cracks or breakage.</li> <li>Visually check for wear on the wheels, look for shavings or flat spots, if not operating properly replace.</li> </ul>	6 Months
2	Drive Wheel	Inspection	<ul style="list-style-type: none"> <li>Inspect the drive shaft for any fractures and damage.</li> <li>Check alignment of the shaft between bearing by observing how the wheel sits in the frame and how it follows the turntable track.</li> <li>Check mounting hardware for proper tightness. Look for paint mark alignment on hardware-retighten if necessary.</li> <li>Check the condition of the wheel surface. It should not have any cracks or breakage.</li> <li>Visually check for wear on the wheels, look for shavings or flat spots, if not operating properly replace.</li> </ul>	

Item No.	Item Name	Required Operation	Description	Interval
3	Pillow Block Bearing	Inspection	<ul style="list-style-type: none"> <li>• Check mounting hardware for proper tightness. Look for paint mark alignment on hardware – retighten if necessary.</li> <li>• Check for housing damage.</li> <li>• Check for binding or sticking in the bearing housing.</li> <li>• Check alignment of the shaft between bearings.</li> </ul>	6 Months
		Lubrication	<ul style="list-style-type: none"> <li>• Bearing is “Lubed for Life”</li> </ul>	
4	Cardan Shaft	Inspection	<ul style="list-style-type: none"> <li>• Inspect all connections and make sure they are secure, check all paint marks. Retighten as necessary.</li> <li>• Inspect shaft and flanges for any cracks or damage, replace if damage is found.</li> </ul>	3 Months
		Lubricate	<ul style="list-style-type: none"> <li>• Use a grease gun to apply grease, carefully pump grease into the zerk fitting.</li> <li>• Coupling is fully lubricated when you see grease leak from all four seals. Clean off all excess grease.</li> </ul>	
5	Guide Roller	Inspection	<ul style="list-style-type: none"> <li>• Check mounting hardware for proper tightness. Look for paint mark alignment – retighten if necessary.</li> <li>• Inspect the roller surface for wear or damage.</li> <li>• Check for slop or play, tighten if necessary.</li> <li>• Check that the roller moves smoothly. If it sticks or snags it may need to be replaced.</li> </ul>	6 Months
6	Rail	Inspection	<ul style="list-style-type: none"> <li>• Check for damage or contaminants. Clean as needed.</li> </ul>	
7	Code Rail Reader Head	Inspection	<ul style="list-style-type: none"> <li>• Verify functionality.</li> <li>• Clean lens with soft cloth.</li> <li>• Check reader head assembly is secure.</li> </ul>	
	Code Rail	Inspection	<ul style="list-style-type: none"> <li>• Verify that code tape is clean and not damaged.</li> </ul>	

Item No.	Item Name	Required Operation	Description	Interval
8	Gearmotor	Inspection	<ul style="list-style-type: none"> <li>• Visually inspect gear unit for oil leakage. Check for oil film or grease deposits – clean if necessary.</li> <li>• Check mounting hardware, check paint marks and tighten any bolts that are off the mark.</li> <li>• Check gearmotor for excessive noise. Remove the oil level plug to check the level of oil.</li> </ul>	<b>6 Months</b>
		Lubrication	<ul style="list-style-type: none"> <li>• Replace the oil in the gearbox after 3 years of use.</li> </ul>	<b>36 Months</b>

# Skillet Power Roll Bed Preventative Maintenance

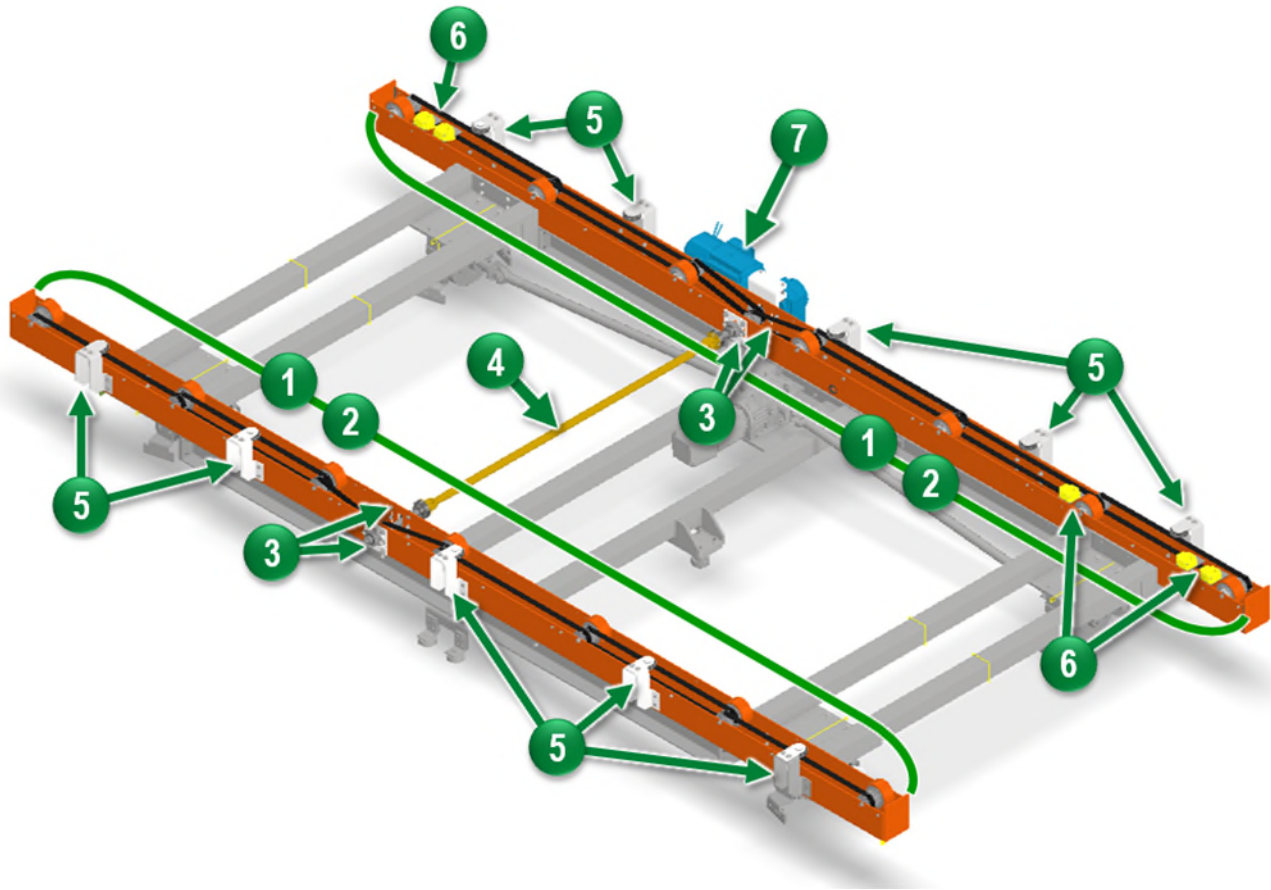

Item No.	Item Name	Required Operation	Description	Interval
1	Drive and Driven Rollers	Inspection	<ul style="list-style-type: none"> <li>Check rollers for clearance, damage, and wear.</li> <li>Abrasion should not exceed 5 mm in diameter (minimum diameter is 140 mm), unevenness at the surface maximum 35 mm.</li> </ul>	3 Months
2	Drive and Driven Belts	Inspection	<ul style="list-style-type: none"> <li>Check that belts run freely and without excessive noise.</li> <li>Check for excessive fraying on belt edges and for any exposed reinforcing wires.</li> </ul>	
3	Flange Bearing	Inspection	<ul style="list-style-type: none"> <li>Check mounting hardware for proper tightness. Look for paint mark alignment on hardware – retighten if necessary.</li> <li>Check for housing damage.</li> <li>Check for binding or sticking in the bearing housing.</li> <li>Check alignment of the shaft between bearings.</li> </ul>	
		Lubrication	<ul style="list-style-type: none"> <li>Bearing is “Lubed for Life”</li> </ul>	

Item No.	Item Name	Required Operation	Description	Interval
4	Cardan Shaft	Inspection	<ul style="list-style-type: none"> <li>Inspect all connections and make sure they are secure, check all paint marks. Retighten as necessary.</li> <li>Inspect shaft and flanges for any cracks or damage, replace if damage is found.</li> </ul>	<b>3 Months</b>
		Lubricate	<ul style="list-style-type: none"> <li>Use a grease gun to apply grease, carefully pump grease into the zerk fitting.</li> <li>Coupling is fully lubricated when you see grease leak from all four seals. Clean off all excess grease.</li> </ul>	
5	Guide Wheels	Inspection	<ul style="list-style-type: none"> <li>Check for steady running, wear or damage.</li> </ul>	
6	Sensors	Inspection	<ul style="list-style-type: none"> <li>Check for proper operation and secure mounting.</li> <li>Check that cables are connected securely.</li> </ul>	
7	Gearmotor	Inspection	<ul style="list-style-type: none"> <li>Use the oil sight glass or remove the oil level plug to check the level of oil.</li> <li>Check that all electrical connections are secure. If loose, tighten.</li> <li>Check the electrical connections for evidence of arcing. If evidence of arcing has occurred, replace the damage connection.</li> </ul>	
		Lubrication	<ul style="list-style-type: none"> <li>Replace the oil in the gearbox after 3 years of use.</li> </ul>	

## Lubrication Requirements - Gearmotor Oil Lubrication

Gearmotor oil can be determined by reading the attached data plates on each gearmotor. The examples below highlight the location to observe the required oil on the data plates. Do not mix oil grades when adding oil. Refer to the manufacturer's instruction manual for additional service requirements and technical data.

### NOTICE

If you are doing a lubricant drain and refill, gearmotor manufacturers typically recommend that you use the same brand of lubricant originally supplied. If you are refilling the gearbox with a non-compatible lubricant, FATA recommends that you first remove any residual with a petroleum solvent or a hot water wash.

### CAUTION

Do not use trichloroethylene as a washing solvent.

Data plates on the gearmotors identify the oil type and quantity that they use.

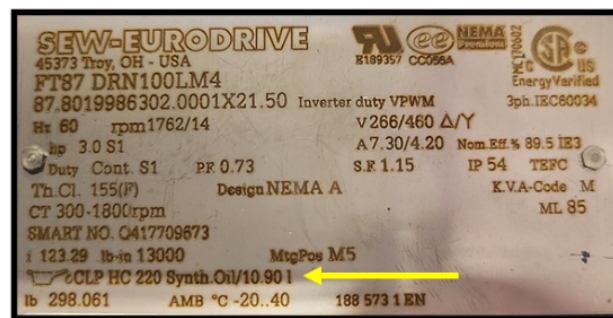
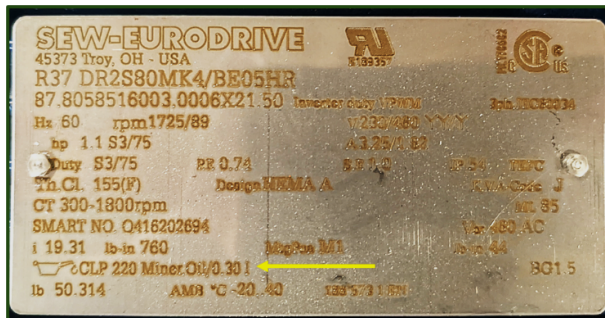

Gearmotor Data Plate Examples

## How to Check Oil Level of SEW Gearmotor

1. Locate the positions of the oil level plug and the breather valve.
2. If the gearmotor is equipped with an oil sight glass, you can determine the oil level according to the figure on the right.
3. If the gearmotor does not have a site glass, place a container underneath the oil level plug.
4. Slowly unscrew the oil level plug. Small amounts of oil may leak out as the permitted maximum oil level is higher than the lower edge of the oil level bore.
5. Check the oil level according to the following figure and the corresponding table.

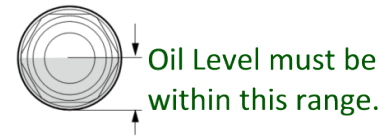
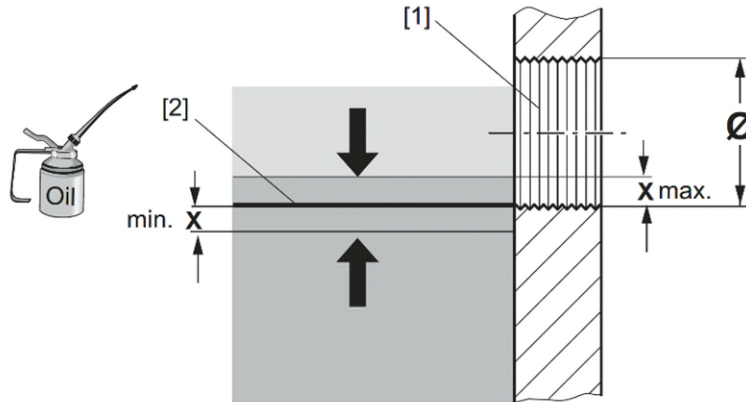
[1] Oil Level Bore [2] Oil Level Setpoint [X] Min./Max. Oil Level

Ø Oil Level Bore	Approved fluctuation "x" of the oil level [mm]
M10 x 1	1.5
M12 x 1.5	2
M22 x 1.5	3
M33 x 2	4
M42 x 2	5

6. If the oil level is too low, proceed as follows:
  - a. Remove the breather valve from the breather bore.
  - b. Fill in fresh oil of the same type via the breather bore, up to the lower edge of the oil level bore.
  - c. Screw in the breather valve again. When doing this, please observe tightening torques.
7. Screw in the oil level plug again. When doing this, please observe tightening torques below for oil level plugs, oil drain plugs, breather valves, and oil sight glasses:

Thread	Tightening Torque (Nm)
M10 x 1	12
M12 x 1.5	15
M22 x 1.5	60
M33 x 2	100
M42 x 2	150

## Checking the Oil Consistency of SEW Gearmotor via Oil Drain Plug

1. Locate the positions of the oil level plug and the breather valve.
2. Remove a little oil from the oil drain plug.
3. Check the oil consistency:
  - a. Viscosity (have this carried out by a suitable laboratory if necessary)
  - d. If you can see that the oil is heavily contaminated, it is advisable to change the oil, even if this is outside the specified service intervals.
  - b. Check the oil level according **How to Check Oil Level of SEW Gearmotor** on previous page.

## Checking the Oil of SEW Gearmotor via Oil Drain Plug and Breather Valve

1. Locate the positions of the oil level plug and the breather valve.
2. Place a container underneath the oil drain plug.
3. Remove the oil level plug, the breather valve and the oil drain plug.
4. Drain all the oil.
5. Re-insert the oil drain plug. When doing this, please observe tightening torques.
6. Fill in fresh oil of the same type via the breather bore. Do not mix different synthetic lubricants.
  - a. Observe the oil quantities according to the specifications on the nameplate.
  - b. Check the oil level at the oil level plug.
7. Re-insert the oil level plug and the breather valve. When doing this, please observe tightening torques.

## Lubrication Requirements - Bearing Grease

The table below lists the plant-approved lubricants for conveyor components that need lubrication.

### Plant-Approved Lubrication Chart

Lubrication Name	Manufacturer	Conveyor Asset	Application Points
<p><i>FATA Automation recommends using Castrol Molub-Alloy 860/220-1 or equivalent plant-specific approved lubricant where applicable. Please consult with your facility lubricant specialist for specific requirements.</i></p>			

### Re-Lubrication Best Practices:

- Always clean the grease fitting of all dirt before attaching the grease gun. Failure to clean the grease fitting before applying grease could result in introducing contaminants into the component resulting in increased wear or clogging the grease fitting orifice so as not to allow the entry of grease. Inspect and replace damaged fittings. It is helpful to use grease-fitting caps to keep them clean, but still wipe fittings clean before applying grease.
- Always make sure the dispensing nozzle of the grease gun is clean before using. Pump a small amount of grease out of the dispensing nozzle, then wipe the nozzle off with a clean rag or lint-free cloth before attaching it to the grease fitting.
- Do NOT over lubricate or apply excessive amounts of grease. This could lead to ruptured seals and excessive grease outside the fitting, which can attract contamination as well as create a mess on the machine.
- Know that some greases are not compatible with each other. Ensure that the proper grease is used at every grease point. Applying the wrong grease can cause an incompatibility problem which can quickly cause bearing failure.
- Once relubrication service is complete, clean off old grease and contaminants from the boot, grease/zerk fitting and surrounding components.